

MBL Series Mini Backlight

EDGE-ENHANCING

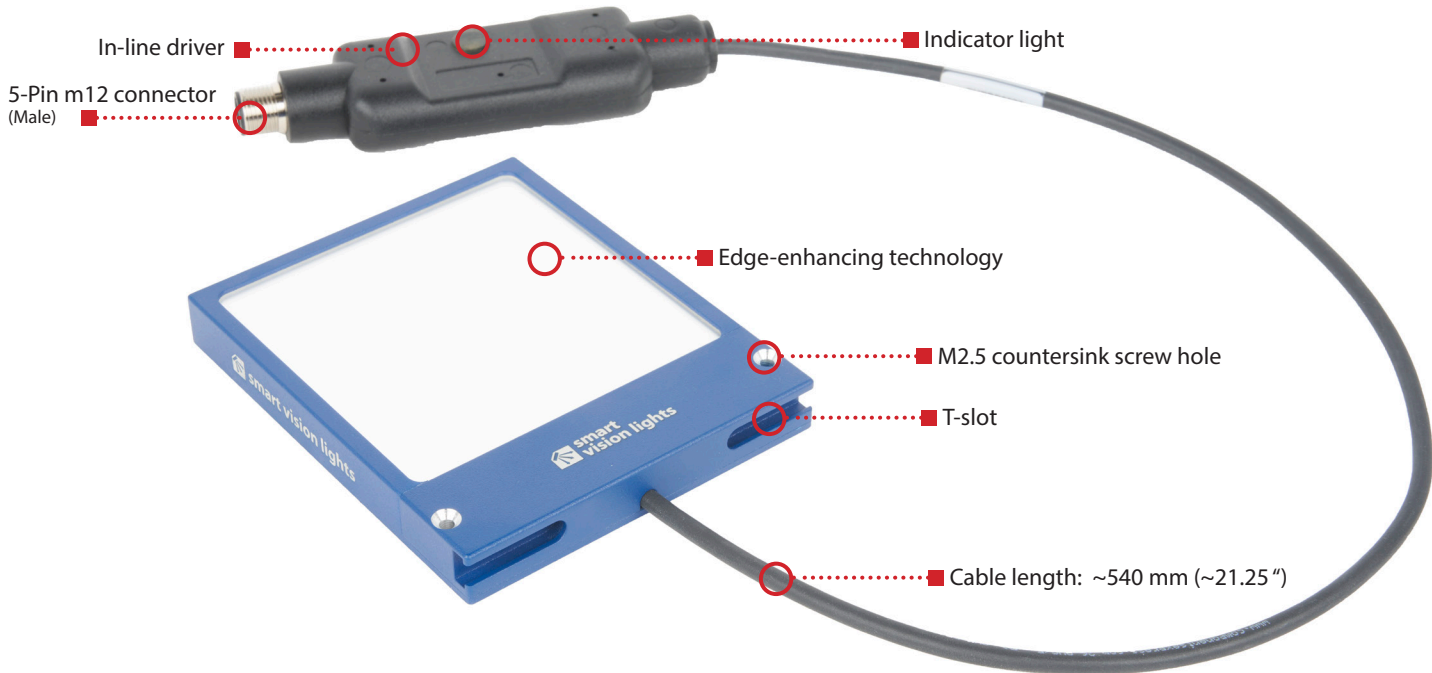

The MBL Series of backlights are mini back lights with an ultra-slim design. Edge-enhancing technology is built-in to provide maximum contrast to backlit objects, providing the ability to get sharp images of round and highly reflective objects. The MBL Series are Multi-Drive™ lights capable of being adjusted remotely from a smart phone or tablet through SmartVisionLink¹.

MBL SERIES HIGHLIGHTS

| | | | | |
|--------------------------------|--------------------------------|--|--|-----------------------------------|
| Warranty 10 YEAR | Tested IEC 62471 | Compliant ² CE ROHS | Rated ³ IP 50 | Connector 5-PIN M12 |
|--------------------------------|--------------------------------|--|--|-----------------------------------|

- ✓ Small form factor for easy installation
- ✓ Edge-enhancing technology built-in for high contrast inspections
- ✓ Comes in four sizes. 25x25, 50x50, 75x75, 100x100⁴
- ✓ Built-in Multi-Drive™ driver provides ability to easily switch between continuous operation and OverDrive™ strobe mode.

¹SmartVisionLink™ requires the BTM-1000 bluetooth module, sold separately, and the free SmartVisionLink™ app.

²Pending

³Pending

⁴Size is based off of the area of illumination and is measured in millimeters.



SPECIFICATIONS

| | Continuous Operation | | OverDrive Operation | |
|------------------------|---|--------------------------|--|---------------------------------------|
| Electrical Input | 24 VDC +/- 5% | | | |
| Input Current | MBL-25x25: Max 0.2 A | MBL-75x75: Max 0.4 A | MBL-25x25: Peak 0.3 A during strobe | MBL-75x75: Peak 2.3 A during strobe |
| | MBL-50x50: Max 0.33 A | MBL-100x100: Max. 500 mA | MBL-50x50: Peak 1.1 A during strobe | MBL-100x100: Peak 5 A during strobe |
| Input Power | MBL-25x25: Max 4.8 W | MBL-75x75: Max 9.6 W | MBL-25x25: Peak 7.2 W during strobe | MBL-75x75: Peak 55 W during strobe |
| | MBL-50x50: Max 7.9 W | MBL-100x100: Max 12 W | MBL-50x50: Peak 26 W during strobe | MBL-100x100: Peak 120 W during strobe |
| PNP Trigger | 2 mA @ 4VDC 7 mA @ 12VDC 13.4 mA @ 24VDC | | | |
| NPN Trigger | 12 mA @ Common (0VDC) | | | |
| Trigger Input | PNP > +3.3 VDC (24 VDC max.) to activate or NPN ≥ GND <1VDC to activate (not both) | | | |
| Mode Control | Connect pin 5 to 1-10 VDC (10 - 100% output); 24 VDC (Max) | | Connect pin 5 to GND (See wiring configuration for more information) | |
| Strobe Duration | Min. 30 μs Max. ∞ | | Min. 30 μs Max. 50 ms | |
| Strobe Frequency | Not applicable | | Max 4 kHz or 1 / Duty Cycle as calculated, whichever is less. ¹ | |
| Strobe Trigger Latency | 10 μs | | 6 μs | |
| Duty Cycle | Not applicable | | Max 10% ¹ | |
| Indicator Light | Turns green when powered up | | | |
| Analog Intensity | The output is adjustable from 10% - 100% of intensity limit by a 1 - 10 VDC signal. Jumping pin 5 to pin 1 will provide maximum intensity. Intensity can be remotely adjusted via SmartVisionLink™ ² | | | |
| Connection | 5-pin M12 connector | | | |
| Operating Temperature | -10° to 40° C (14° - 104° F) 80% RH non-condensing | | | |
| Storage Temperature | -20° to 70° C (-4° - 158° F) 80% RH non-condensing | | | |
| IP Rating (Pending) | IP50 | | | |
| Weight | MBL-25x25: ~0.1kg 0.25lbs | | MBL-75x75: ~0.22 kg 0.45 lbs | |
| | MBL-50x50: ~0.13 kgs 0.30 lbs | | MBL-100x100: ~0.27 kgs 0.60 lbs | |
| Compliances (Pending) | FCC, CE, CSA, KC, UL61010, RoHS, REACH, WEEE, IEC 62471 | | | |
| Warranty | 10 years ³ | | | |

¹See page 4 for more information

²SmartVisionLink™ requires the purchase of the BTM-1000 bluetooth module, sold separately, and the SmartVisionLink™ app, free to download on the Apple App and Google Play stores.

³See SmartVisionLights.com/warranty for details.

WIRING CONFIGURATION

CONTINUOUS OPERATION MODE

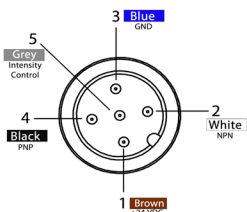

| Pins | Function | Signal | Wire Color |
|------|-------------------|-----------------|------------|
| 1 | Power In | +24VDC | BROWN |
| 2 | NPN | Sinking Signal | WHITE |
| 3 | GND | Ground | BLUE |
| 4 | PNP | Sourcing Signal | BLACK |
| 5 | Intensity Control | 1-10VDC | GREY |

For maximum intensity, tie pin 5 to pin 1 at +24 VDC.

For continuous mode: PNP (pin 4) can be tied to +24 VDC (pin 1) **or** NPN (pin 2) can be tied to Ground (pin 3).

For proper light function, apply either a PNP or NPN signal, **not both**.

Failure to supply light with correct input current will result in inconsistent lighting behavior.

(See Product Specifications for requirements)

WIRING CONFIGURATION

OVERDRIVE™ OPERATION MODE

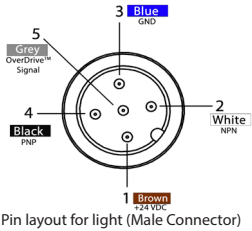

| Pins | Function | Signal | Wire Color |
|------|-------------------|-----------------|------------|
| 1 | Power In | +24VDC | BROWN |
| 2 | NPN | Sinking Signal | WHITE |
| 3 | GND | Ground | BLUE |
| 4 | PNP | Sourcing Signal | BLACK |
| 5 | OverDrive™ Signal | Ground | GREY |

To enable OverDrive™ mode, tie pin 5 to pin 3.

For proper light function, apply either a PNP or NPN signal, not both.

Failure to supply light with correct input current will result in inconsistent lighting behavior.
(See Product Specifications for requirements)

OPTICAL PERFORMANCE

Illuminance values taken at surface of the light using white light - 5700K.

Surface Illuminance (Lux)

| | Continuous Operation | OverDrive™ Operation |
|-------------|----------------------|----------------------|
| MBL-25x25 | 190,000 | 230,000 |
| MBL-50x50 | 140,000 | 302,000 |
| MBL-75x75 | 120,000 | 550,843 |
| MBL-100x100 | 90,000 | 475,946 |

Peak Luminance (Cd/m²)

| | Continuous Operation | OverDrive™ Operation |
|-------------|----------------------|----------------------|
| MBL-25x25 | 168,000 | 207,000 |
| MBL-50x50 | 100,000 | 270,000 |
| MBL-75x75 | 114,000 | 521,000 |
| MBL-100x100 | 84,000 | 445,000 |

BEAM PATTERNS

The MBL Series offers a diffuse light pattern. Beam patterns show surface of the light using white light - 5700K.

MBL-25x25

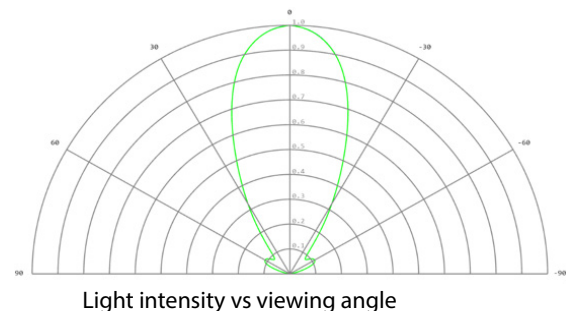
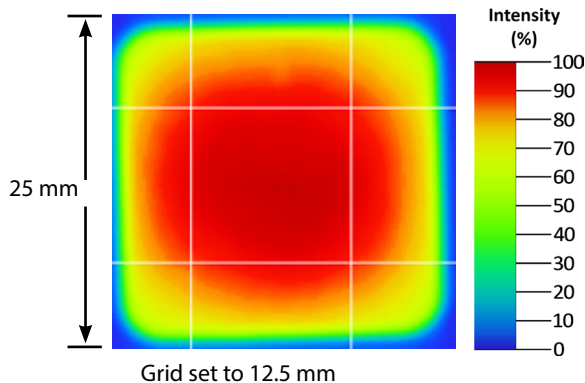

BEAM PATTERNS (continued)

The MBL Series offers a diffuse light pattern. Beam patterns show surface of the light using white light - 5700K.

MBL-50x50

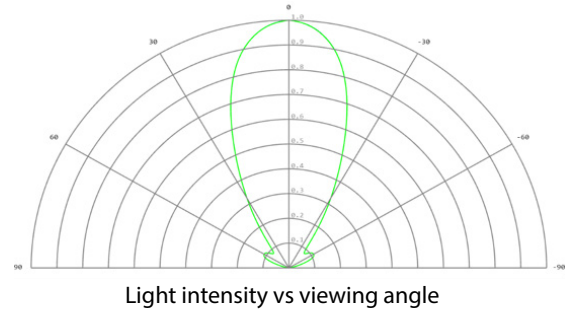
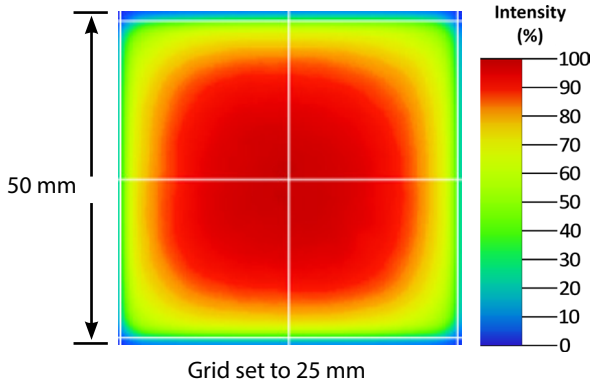

MBL-75x75

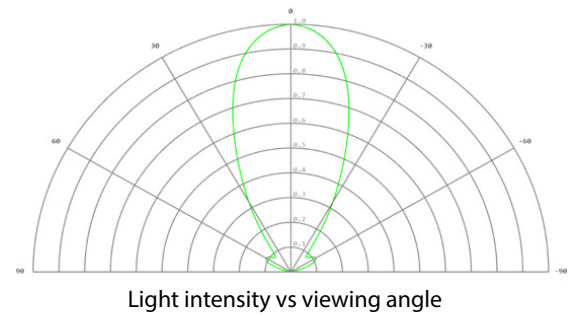
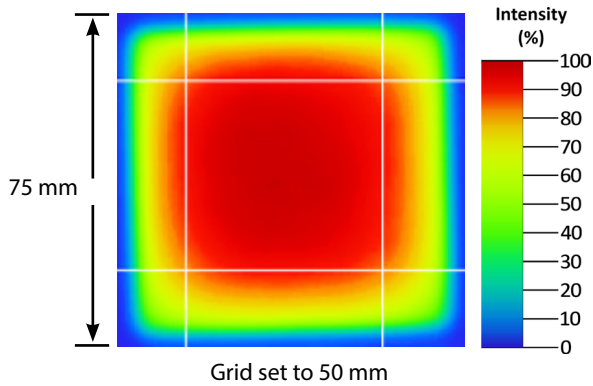

MBL-100x100

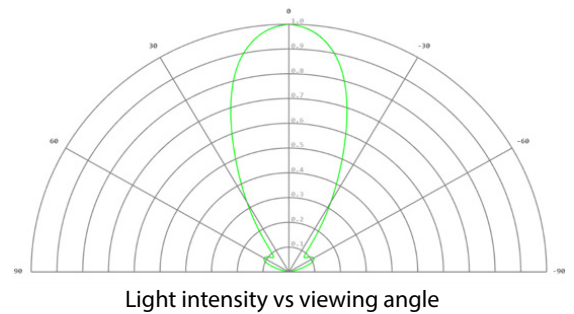
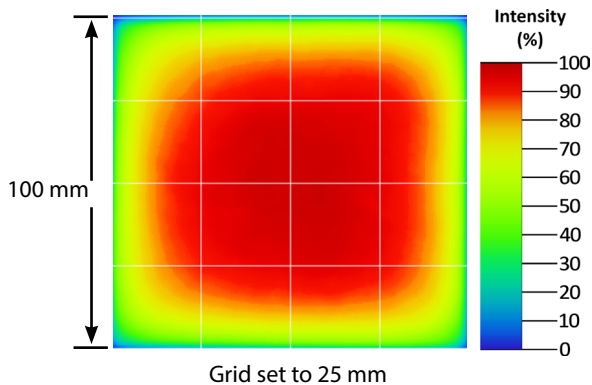

EDGE-ENHANCING TECHNOLOGY

The MBL Series comes with built-in edge-enhancing technology that dramatically increases contrast in backlit images.

Standard Backlight

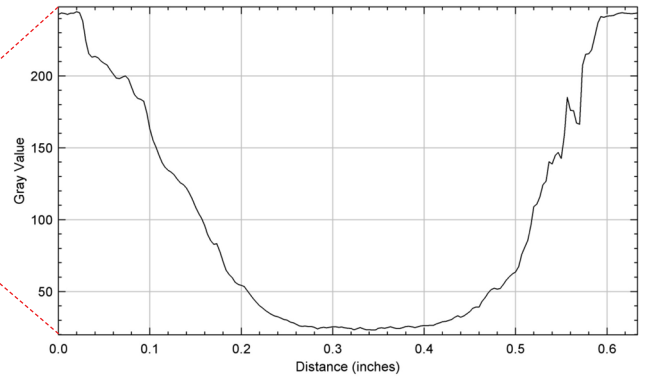

Edge-Enhanced Backlight

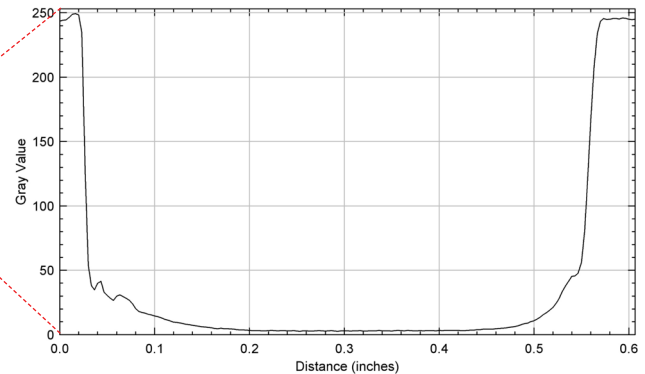

EYE SAFETY

According to IEC 62471:2006. Full documentation available upon request with purchase of product.

Notice

Exempt Group: No photobiological hazard to eyes or skin even for continuous, unrestricted use. Applicable for wavelengths 625 and 850.

Caution

Risk Group 1: Possibly hazardous optical radiation emitted from this product. Do not stare at operating lamp. May be harmful to eyes. Safe for most applications except prolonged exposure. Applicable for wavelengths 470 and WHI.

ILLUMINATION

The MBL Series works best for:

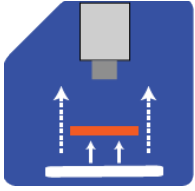

Backlight

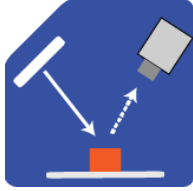

Bright Field

DUTY CYCLE

This section applies only if light is in OverDrive™ strobe mode.

The Duty Cycle (D) is related to the Strobe Time (ST) and Rest Time (RT).

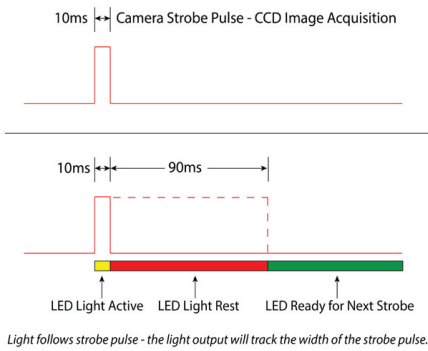

Calculating Rest Time

$$RT = \frac{ST}{D} - ST$$

RT = Rest Time
ST = Strobe Time
D = Duty Cycle

Example

$$90 \text{ ms} = \frac{10 \text{ ms}}{.1} - 10 \text{ ms}$$

Rest Time is 90 ms for 10 ms Strobe Time

Calculating Strobe Rate

$$SR = \frac{D}{ST}$$

SR = Strobe Rate (strokes per second)
ST = Strobe Time (seconds)
D = Duty Cycle

Example

$$1000 = \frac{0.1}{0.0001}$$

Strobe Rate is 1000 strokes per second

Calculating Duty Cycle

$$D = ST \times SR$$

SR = Strobe Rate (strokes per second)
ST = Strobe Time (seconds)
D = Duty Cycle

Example

$$0.1 = 0.0001 \times 1000$$

Duty Cycle is 10% (0.1)

Maximum Duty Cycle for OverDrive™ light is 10% (0.1)

Maximum Strobe Frequency is 1/ calculated duty cycle or 4,000 strokes per second, whichever is less.

MOUNTING

T-Slots are located along the bottom of the MBL Series lights.

The MBL Series comes with 2 screws and 2 nuts.



M2.5 countersink mounting holes

T-slots for mounting



MULTI-DRIVE™

Multi-Drive™ provides both continuous and overdrive modes from a single integrated driver. Users can select the lighting mode via the input wiring configuration. With OverDrive™, the light can be strobed at up to 10 times the intensity* of continuous mode.

*Please see lighting section for more information on OverDrive values for this light.



SAFESTROBE™

SafeStrobe™ is a unique technology that applies safe working parameters to ensure high current LEDs are not damaged by driving them beyond their limits, such as maximum strobe time or duty cycle. This is especially beneficial for overdriving our high current LEDs.

SMARTVISIONLINK™

The MBL Series is SmartVisionLink™-enabled and is designed so intensity can be adjusted using the SmartVisionLink™ app.

SmartVisionLink™ provides a way for a light to communicate with an app on a mobile device or tablet. This technology allows users to adjust the intensity of the light in both continuous operation and OverDrive™ strobe mode. By connecting the BTM-1000 Bluetooth module to a light that is SmartVisionLink™-enabled, a user can adjust parameters for the light. The SmartVisionLink™ app is available free to download in the Apple App and Google Play Stores.

The BTM-1000 Bluetooth module acts as an intensity limiting device. Intensity levels set and saved by the module are intensity limits, or ceilings, that the analog signal will then modify.

For example, assume the intensity level is set to 50% by the BTM-1000. If the analog signal is set to 10% intensity, the intensity of the light will be 10% of the 50% ceiling, rather than 10% of the lights total limit.



PART NUMBER GUIDE

MBL – **X** –

SIZE (L x W):

25 x 25

50 x 50

75 x 75

100 x 100

COLOR:

WHI

470

625

850

Part Number Examples:

MBL-50x50-WHI MBL, 50x50 mm, white

MBL-100x100-625 MBL, 100 x 100 mm, 625 nm red wavelength

Sizes listed are in millimeters.

ACCESSORIES

| Power Cables | |
|---|-------------|
|  | |
| Lengths | Part Number |
| 5 m | 5PM12-5 |
| 10 m | 5PM12-10 |
| 15 m | 5PM12-15 |

| SmartVisionLink™ | |
|--|------------------|
|  | |
| Part Number | Description |
| BTM-1000 | Bluetooth Module |

| Replacement Mounting Kit | |
|---|-------------|
|  | |
| Description | Part Number |
| Mounting Screw | SC0077 |
| Mounting Nut | NU0011 |

Light comes with two screws and two nuts.

PRODUCT DRAWINGS

CAD files are available on our website. Drawings are in mm.

MBL-25x25

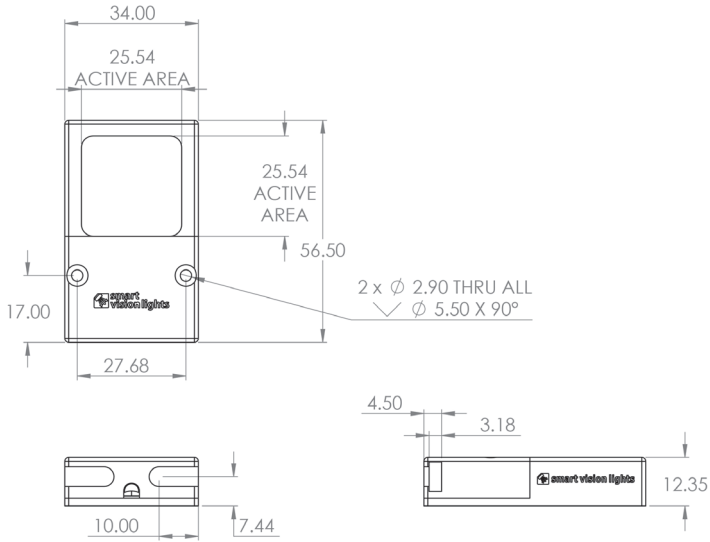

MBL-50x50

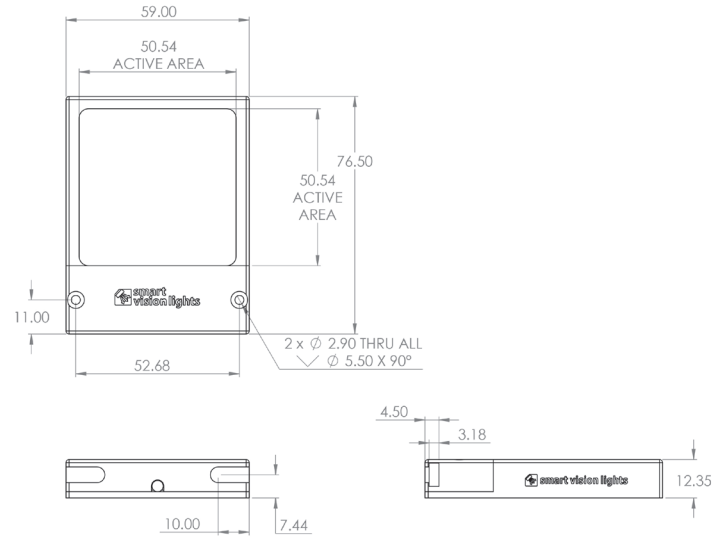

MBL-75x75

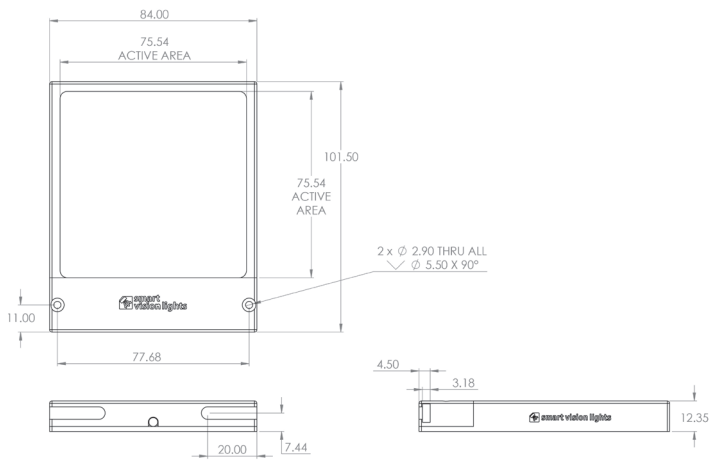

MBL-100x100

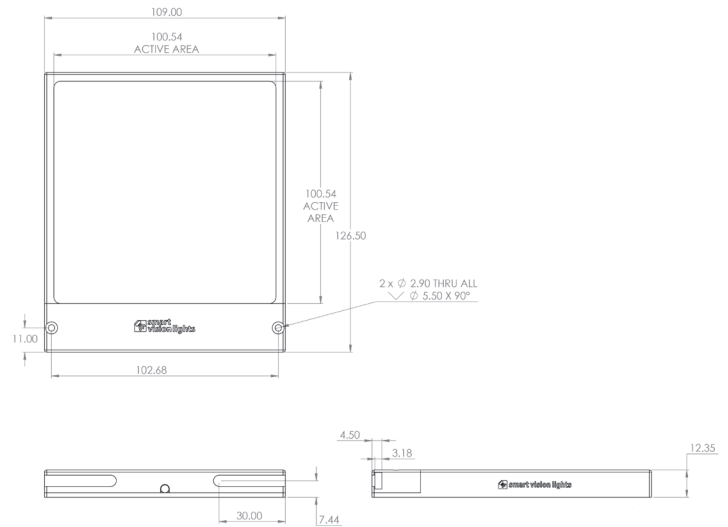

GLOSSARY

This glossary covers all Smart Vision Lights product families; some content in this section may not apply to this specific light.

TERMINOLOGY

Continuous Operation The light stays on continuously.

OverDrive™ Integrated driver that produces a high-current strobe to the LEDs to drive them beyond their nominal continuous operation output.

Multi-Drive™ Integrated driver that combines continuous operation and OverDrive™ strobe mode

NanoDrive™ Integrated driver that provides fast switching where the light can go from off to on in less than 500 ns.

Built-in Driver The driver contained within the light that controls the current to the LEDs and provides PNP, NPN, and analog dimming controls.

SmartVisionLink™ Integrated feature that enables lighting control through the Bluetooth module and app.

Camera to Light Connect the light directly to the camera, without the need for additional controllers or equipment.

Polarizers Filters that reduce reflections on specular surfaces.

Diffusers Widens the angle of emission by scattering light in all directions.

Pattern Area Lighting Modulated lighting pattern placed over a backlight's surface used to enhance defect detection on transparent and glossy surfaces

SafeStrobe Limiter to keep the light in safe working parameters.

Direct Connect Connect lights in a series without the use of cables.

Daisy-Chain Connect lights in a series with the use of cables.

TYPES OF ILLUMINATION

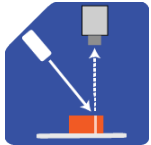

Projector

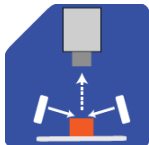

Dark Field

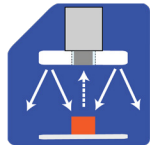

Radial



Bright Field

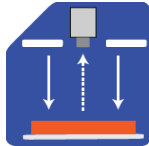

Direct

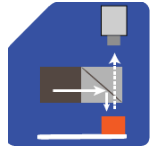

Axial

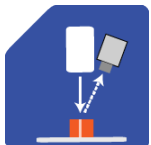

Line

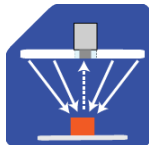

Diffuse Panel

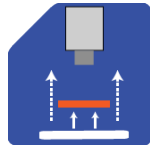

Backlight

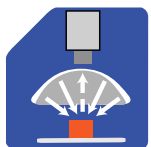

Dome
"Light Tent"

COMMON COLOR / WAVELENGTHS LEGEND

Wavelengths options range from 365 nm to 1650 nm.*
Additional wavelengths available for many light families.

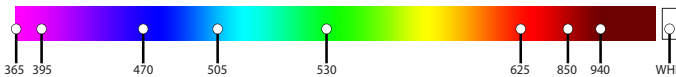

*See Part Number section for **this light's** available standard wavelengths.



Shortwave Infrared LEDs are available in 1050 nm, 1200 nm, 1300 nm, 1450 nm, 1550 nm, and 1650 nm.*

*Check Part Number section to see if **this light** is available in SWIR wavelengths.

